

## Using Physical Modeling Tools to Design Power Optimized Aircraft

Steve Miller

Technical Marketing, Physical Modeling Tools

The MathWorks GmbH, Munich, Germany

Steve.Miller@mathworks.de

# Key Points

1. Testing different actuator designs in one environment saves time and encourages innovation
2. Optimizing systems with respect to design requirements leads to optimal design choices
3. Simulating at different levels of fidelity is required to see effects of design implementation

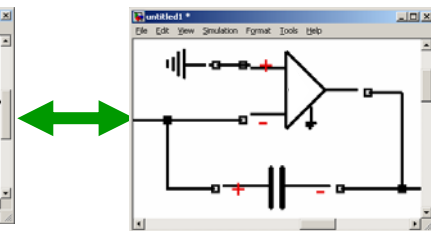
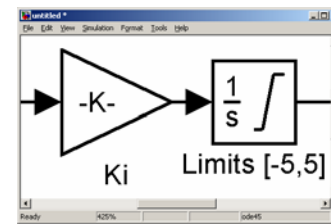
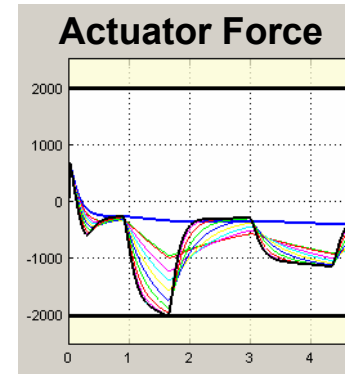
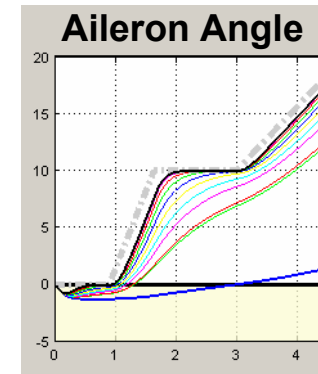
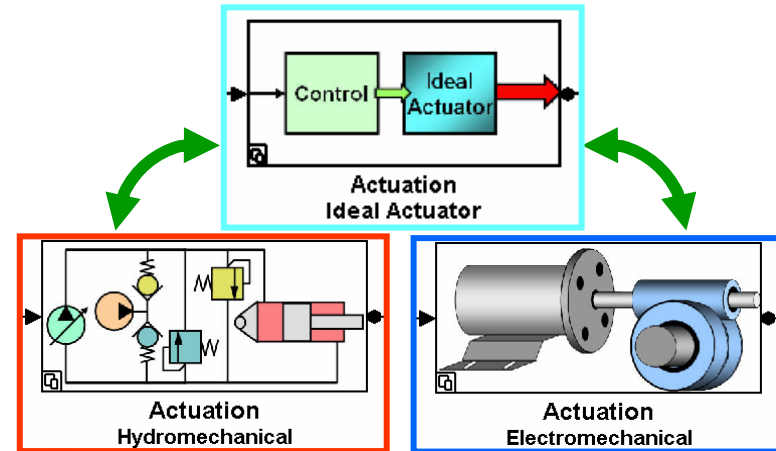

# Agenda

- Trends in the aerospace industry 10 min
  - Industry trends
  - Strategies for improvement
  - How simulation can help
- Example: Flight Actuation System 15 min
  - Model explanation
  - Tradeoff study
  - System optimization
  - Assess implementation effects
- Conclusions

# Industry Trends

- System needs
  - Aircraft must produce less pollution
  - Aircraft must be more efficient
- Example goals
  - Clean Sky (for year 2020)
    - 50% reduction of CO<sub>2</sub> emissions
    - 80% reduction of nitrous oxide emissions
  - Power Optimized Aircraft (POA)
    - 25% cut in peak non-propulsive power
    - 5% reduction in fuel consumption
- Strategies include aircraft-level optimization, technology

*“With 5-6°C warming ... existing models ... estimate an average 5-10% loss in global GDP.”*

Head of the Government Economic Service  
UK, 2006



Research project, EU and industry

# Strategies for Improved Aircraft Design

- Technology: Electrical actuation
  - Fewer losses than hydraulic actuation
  - Only needs to be turned on when in use
  - Tend to be more reliable, cleaner, and safer

**Boeing 787**  
**Electrical Systems**  
*Brakes*  
*Ice protection*  
*Engine start*  
*Environmental controls*  
*Electrohydraulic pumps*

- Aircraft-level optimization
  - Consolidation of power electronics
  - Localize hydraulic actuation

**Airbus 380**  
**Electrical Systems**  
*Primary flight control actuators*  
*Thrust reverser actuation*  
*Horizontal stabilizer backup*

- Simulation can help with each of these strategies

# How Simulation Can Help

1. Tradeoff studies to test electrical and hydraulic systems
  - Determine actuator requirements
  - Test hydraulic and electrical actuator designs
2. System-level models
  - Must be done at aircraft level to optimize architecture
  - Few key parameters and quick simulation
3. Simulating at different levels of fidelity
  - Need to easily add fidelity to see impacts of implementation
  - Reuse work done at system level (Model-Based Design)

# Example: Aileron Actuation System

- System

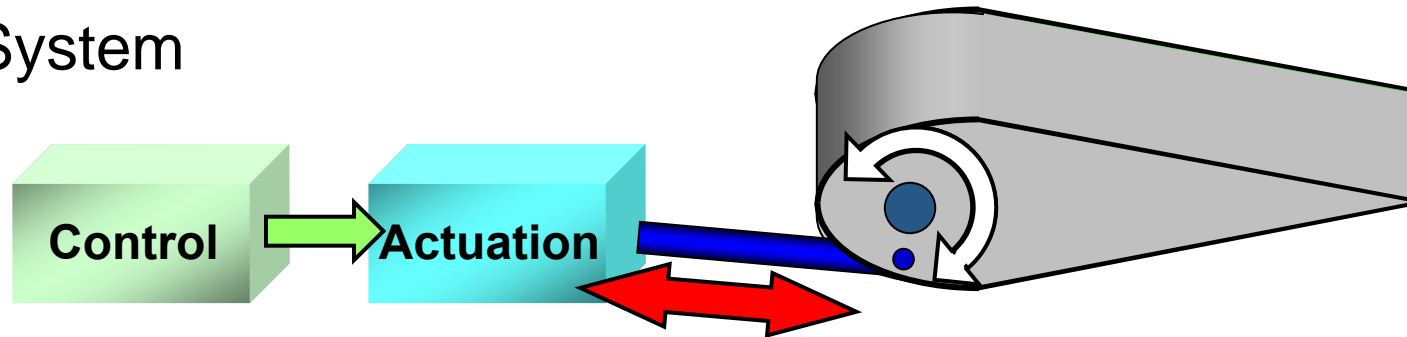

- Simulation goals

1. Determine requirements for actuation system
2. Test performance with electrical or hydraulic actuation
3. Optimize the actuation system
4. Assess effects of system implementation

# Determining Actuation Requirements

## Model:

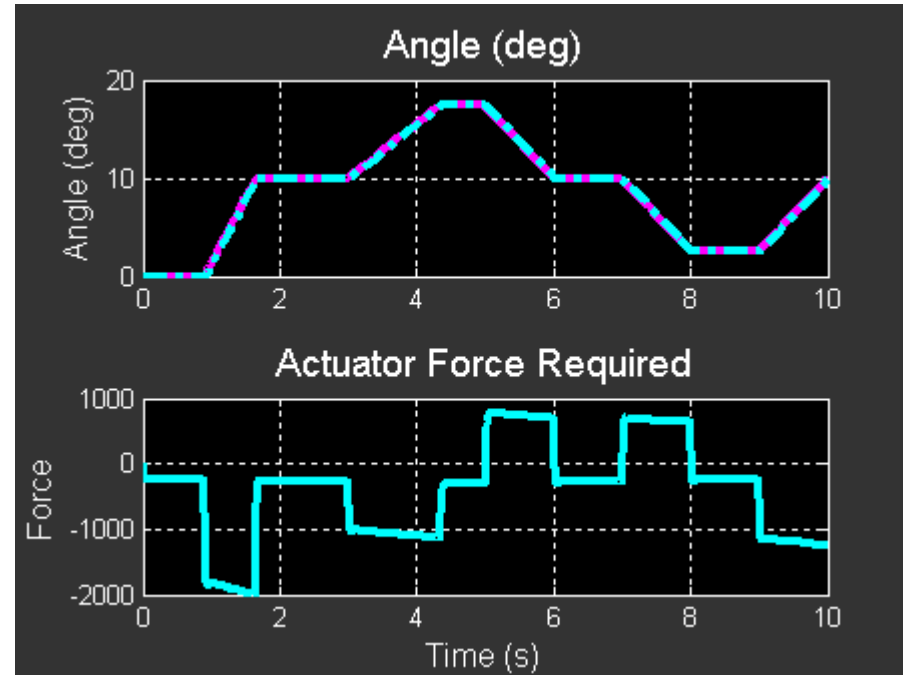
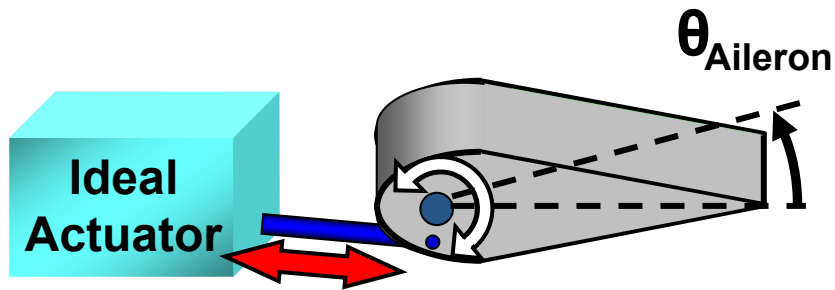

**Problem:** Determine the requirements for an aircraft aileron actuator

**Solution:** Use [SimMechanics™](#) to model the aileron and [Simscape™](#) to model an ideal actuator

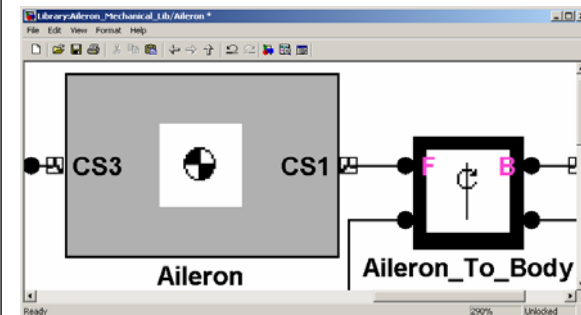
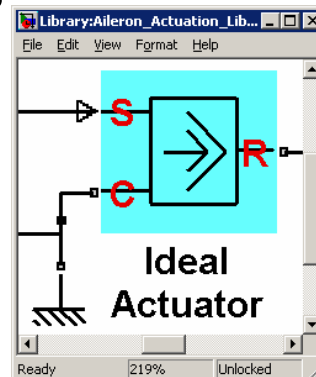



# Test Electrical and Hydraulic Designs

**Model:**

Hydraulic

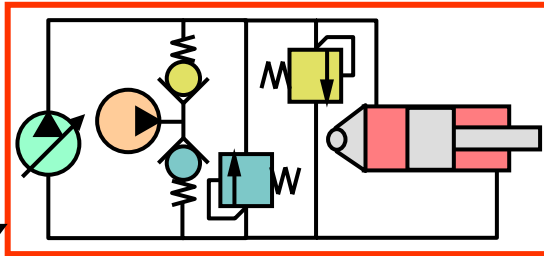

Actuator

Electro-  
mechanical

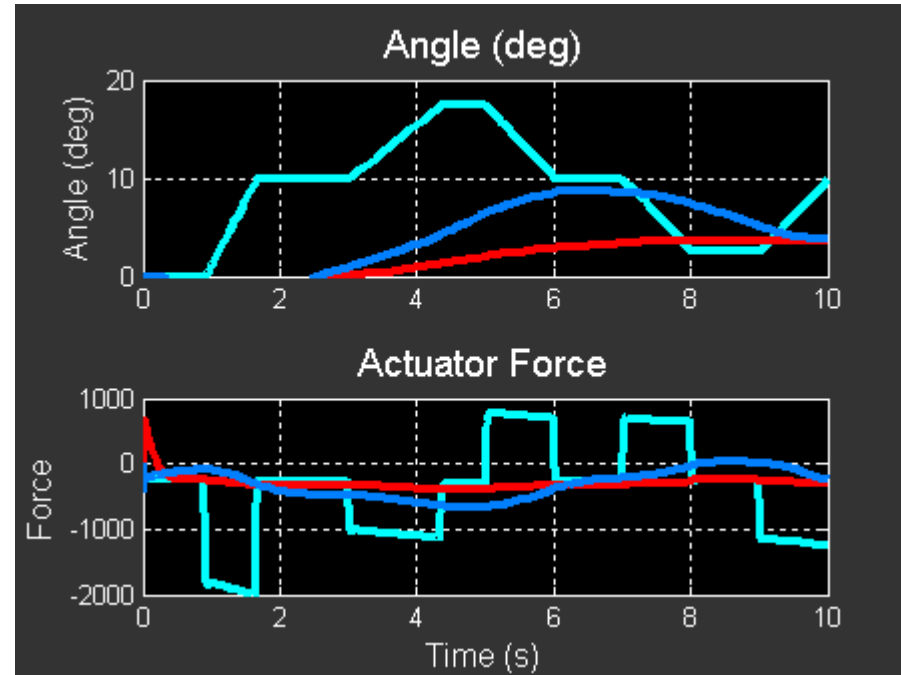
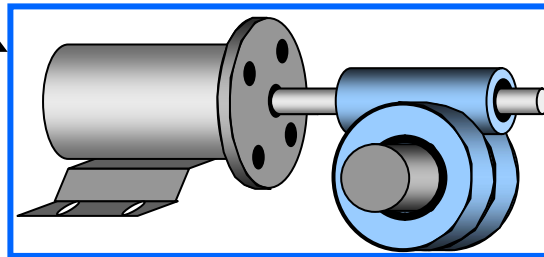

**Problem:** Test different actuator designs in the system

**Solution:** Use [SimHydraulics®](#) and [Simscape](#) to model the actuators, and **configurable subsystems** to exchange them

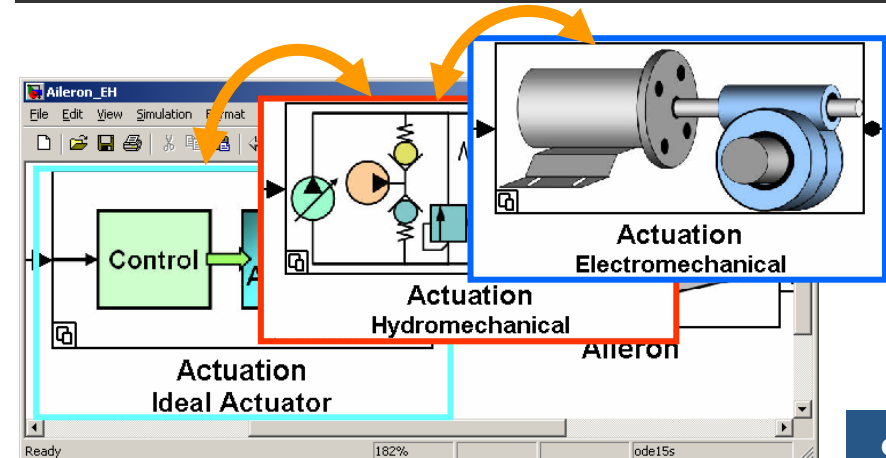

# Actuator System-Level Designs

- Hydrostatic transmission

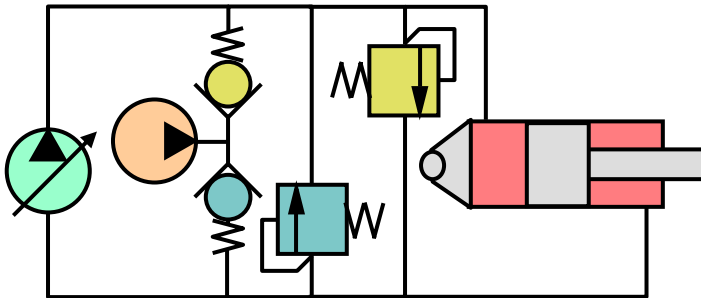

- Variable-displacement pump
- Double-acting hydraulic cylinder
- Replenishing valves
- Pressure-relief valves
- Charge pump
- Speed controller

- Electromechanical system

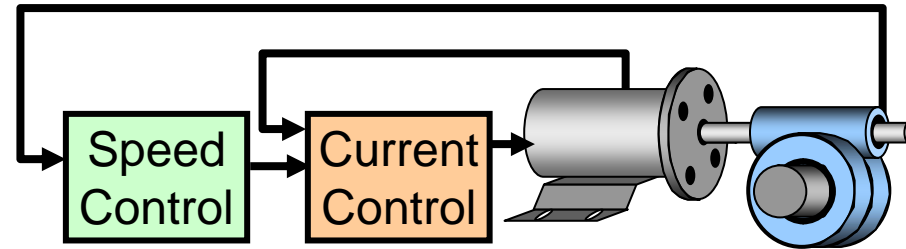

- DC Motor
- Worm gear
- Current sensor and current controller
- Hall effect sensor and speed controller

# Optimize System Performance

## Model:

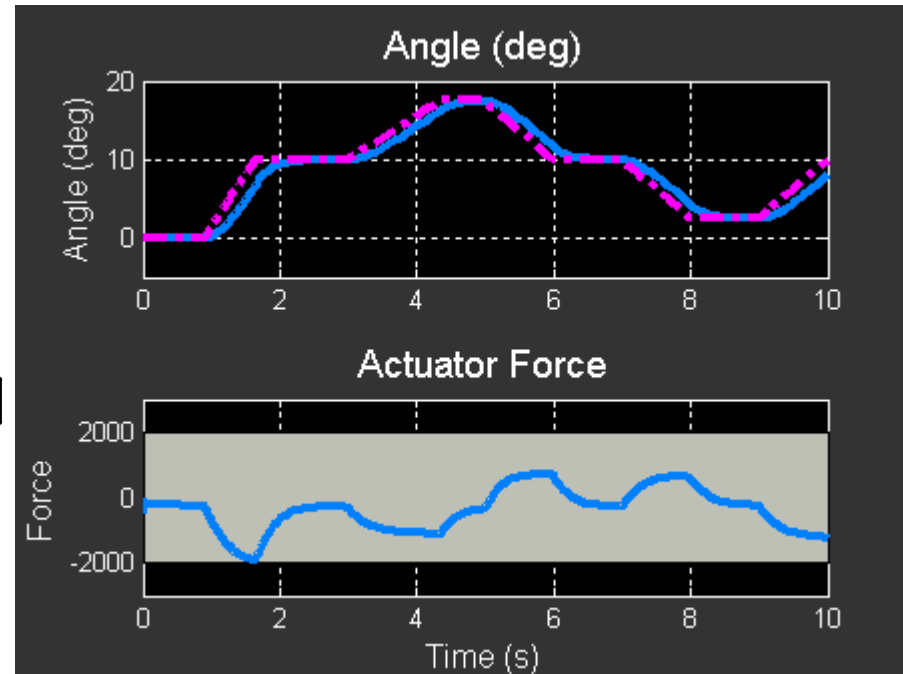
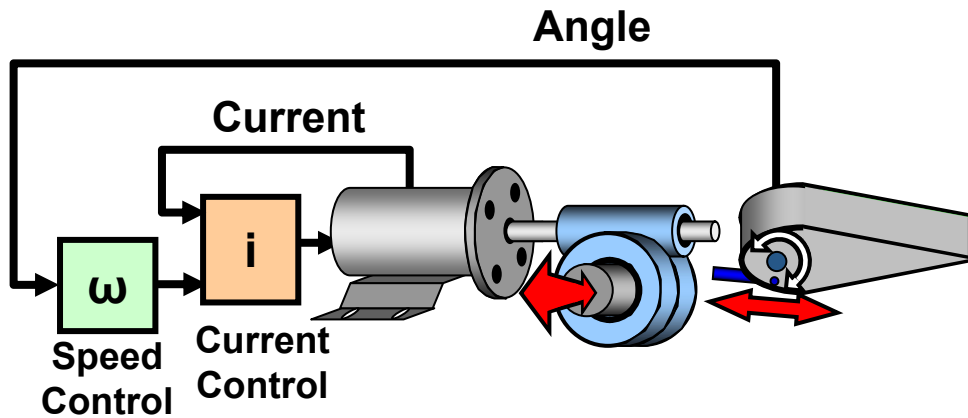

**Problem:** Optimize the speed controller to meet system requirements

**Solution:** Use [Simulink® Response Optimization™](#) to tune the controller parameters

$\omega$ Speed Control	$K_p$	$K_i$
	23.4	3.67

# Assess Implementation Effects

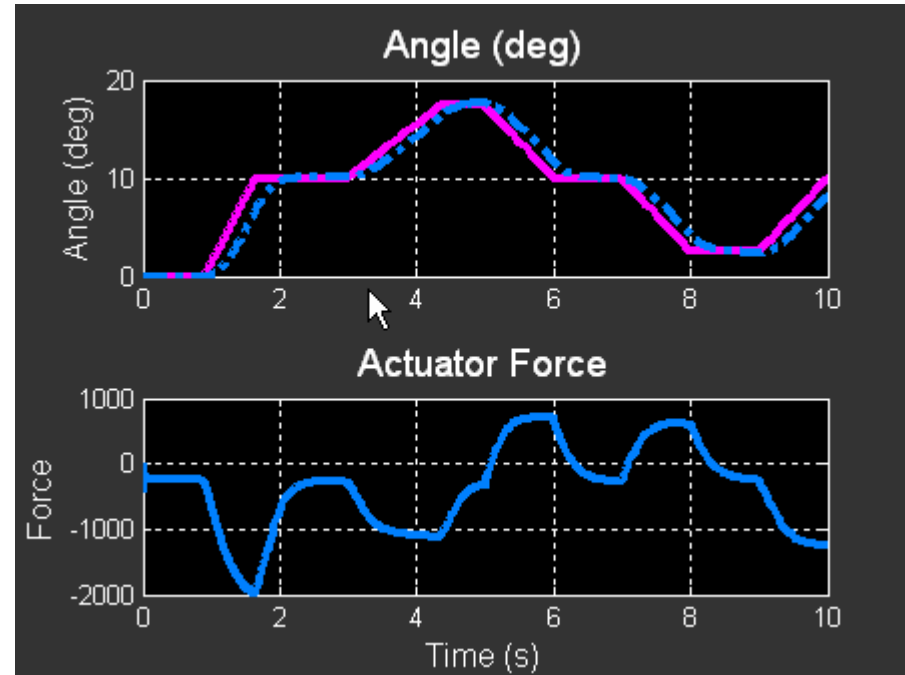
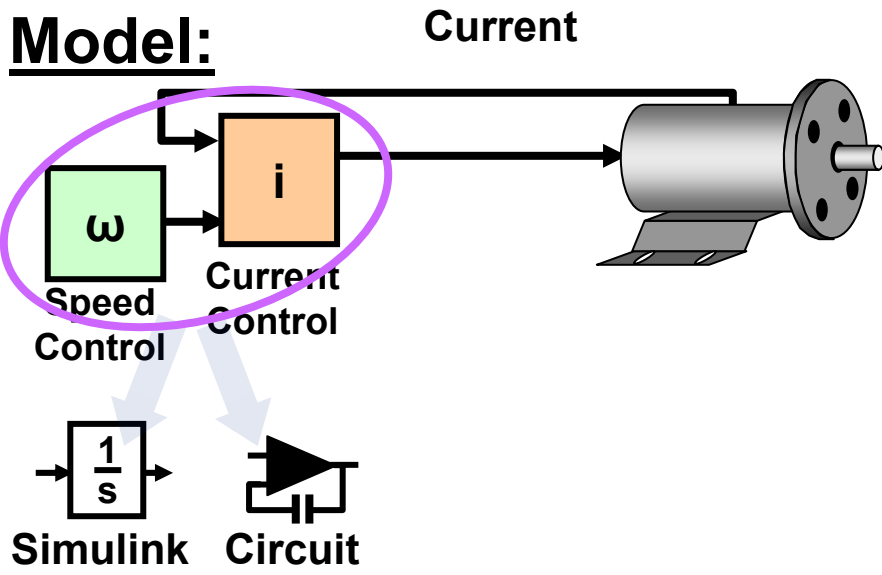

**Problem:** Assess the effects of design implementation on system performance

**Solution:** Use [Simscape](#) to add a the analog circuit implementation

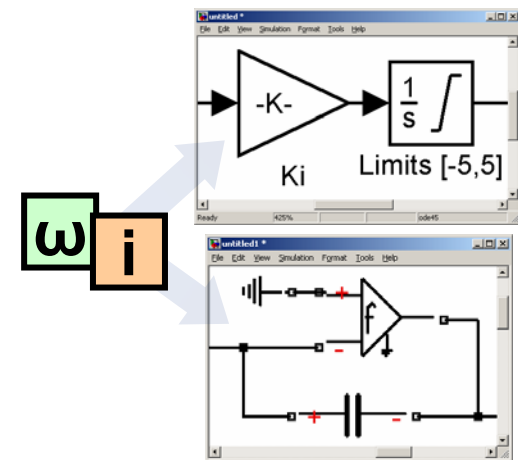

# Conclusion

1. Testing different actuator designs in one environment saves time and encourages innovation
2. Optimizing systems with respect to design requirements leads to optimal design choices
3. Simulating at different levels of fidelity is required to see effects of design implementation

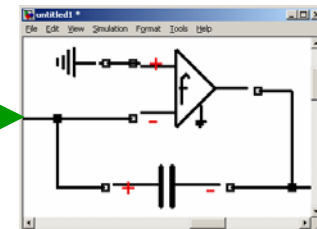
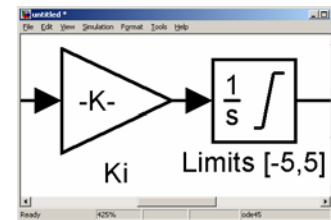
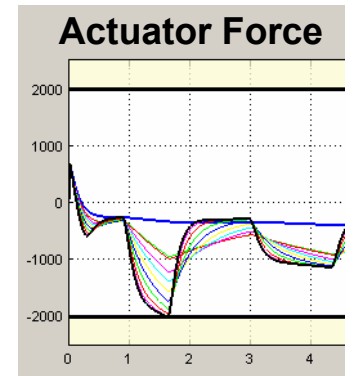
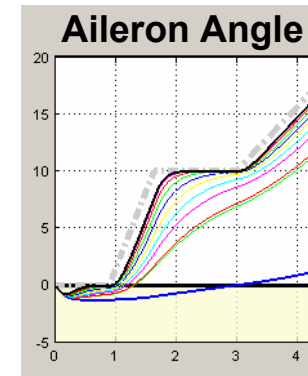
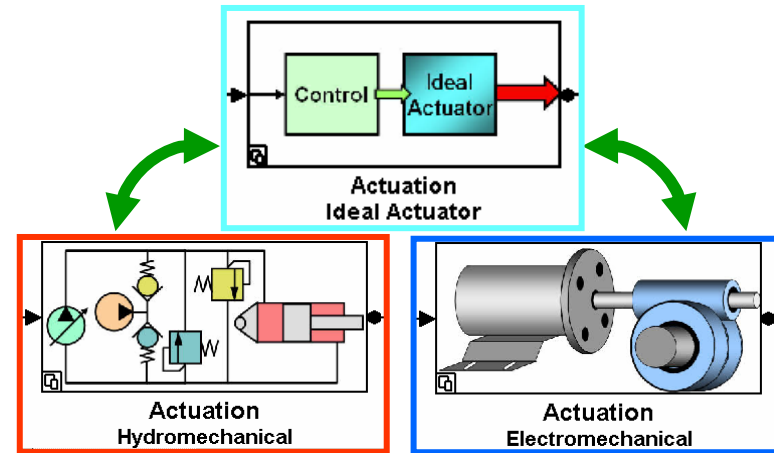

# MathWorks Products Used

- Simscape
  - Multidomain physical systems

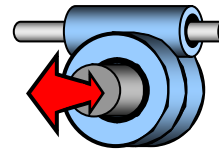
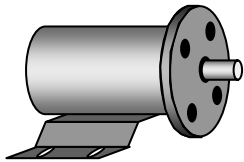

- SimMechanics
  - 3-D mechanical systems

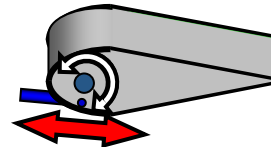

- SimHydraulics
  - Hydraulic (fluid power) systems

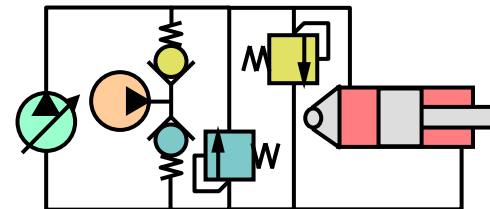

- Simulink Response Optimization

